

PLA DL 210 NET, PLA DL 210 NET D

Digi-Loop™ Large Area DSP Induction Loop Amplifiers

USER MANUAL



Table of Contents

Safety Warnings and Instructions	4
System Overview	6
Crestron Control	7
Dante Audio Input	7
Amplifier Controls and Connectors	7
Typical Connections and Installation	8
Setup and Calibration Procedure	10
Single Perimeter Loop Configuration using front LCD (Dual Loop Mode)	11
Dual Loop Calibration using front LCD (Dual Loop Mode)	12
Phased-Array Calibration using front LCD (Phased Array Mode)	13
One Speaker + Single Loop Calibration using front LCD (Speaker Mode)	14
Front LCD Screen Menu Tree	15
Front Menu Detail	16
1. LOOP STATUS	16
2. HEADPHONE MONITOR	16
2a. Headphone Source	16
3. LOAD PRESET	16
4. CONFIGURATION MENU	17
5. INPUT CONFIGURATION	17
5a1. Name	17
5a2. Input Type	17
5a3. EQ	18
5a4. Compression	18
5a4a-e. Threshold, Ratio, Attack, Release, Makeup	18
6. OUTPUT CONFIGURATION	19
6a. Name	19
6b. Input Mixer	19
6c1-2. Filters	19
6d. AGC	20
6d1-6. AGC Level, Hold Time, Attack, Release	20
6e. Delay	20
6f1-3. EQ - Lo, Mid, Hi	21
6f4a-d. Advanced Settings - Lo, Mid, Hi, Metal Comp	21
6g. Loop Mode	21
7. SYSTEM CONFIGURATION	21
7a1-3. Presets - Load Preset, Save Preset, Change Name	21
7b. RS-232	22

7c. Ethernet	22
7e1-2. Security - Set Password, Password Timeout	23
7f1-2. Power Save - Auto Sleep, Threshold	23
7g. Tech Tools	23
7g1a-c. Calibrate - Output, Frequency, Volume	24
7g2. Loop Test	24
7g3. Version	24
7g4. DL210 Name	24
7g5. NET Info	25
7g6. Amp Temp	25
7g7. Reset All	25
PC Mixer Application and iPad App Initial Setup	26
Using the PC Mixer Application and iPad App	27
Upgrading Firmware	32
Specifications	33
Troubleshooting	34
2-year Warranty	35

Safety Warnings and Instructions

WARNING! TO REDUCE THE RISK OF FIRE OR ELECTRIC SHOCK, DO NOT EXPOSE THIS APPLIANCE TO RAIN OR MOISTURE.

CAUTION! TO REDUCE THE RISK OF ELECTRIC SHOCK, DO NOT REMOVE COVER. NO USER-SERVICEABLE PARTS INSIDE. REFER SERVICING TO QUALIFIED SERVICE PERSONNEL.



This symbol on the amplifier is intended to alert the user to the presence of un-insulated “dangerous voltage” within the products enclosure that may be of sufficient magnitude to constitute a risk of electric shock to persons.



This symbol on the amplifier is intended to alert the user to the presence of important operating and maintenance (servicing) instructions in the literature accompanying the appliance.

POWER CORD NOTICE FOR INTERNATIONAL OPERATION - Please call Williams Sound Customer Service at 800.328.6190 to order the appropriate power cord for the country of use.

Important Safety Instructions:

1. Read these instructions
2. Keep these instructions
3. Heed all warnings
4. Follow all instructions
5. Do not use this apparatus near water.
6. Clean only with dry cloth.
7. Do not block any ventilation openings. Install in accordance with the manufacturer’s instructions.
8. Do not install near any heat sources such as radiators, heat registers, stoves, or other apparatus (including amplifiers) that produce heat.
9. Do not defeat the safety purpose of the polarized or grounding-type plug. A polarized plug has two blades with one wider than the other. A grounding type plug has two blades and a third grounding prong. The wide blade or the third prong is provided for your safety. If the provided plug does not fit into your outlet, consult an electrician for replacement of the obsolete outlet.
10. Protect the power cord from being walked on or pinched particularly at plugs, convenience receptacles, and the point where they exit from the apparatus.
11. Only use attachments/accessories specified by the manufacturer.
12. Unplug this apparatus during lightning storms or when unused for long periods of time.
13. Refer all servicing to qualified service personnel. Servicing is required when the apparatus has been damaged in any way, such as power-supply cord or plug is damaged, liquid has been spilled or objects have fallen into the apparatus, the apparatus has been exposed to rain or moisture, does not operate normally, or has been dropped.
14. The apparatus shall not be exposed to dripping or splashing and that no objects filled with liquids, such as vases, shall be placed on the apparatus.
15. Carts and Stands - The appliance should be used only with a cart or stand that is recommended by the manufacturer. An appliance

and cart combination should be moved with care. Quick stops, excessive force and uneven surfaces may cause the appliance and cart combination to overturn.

16. Wall or ceiling Mounting - The appliance should be mounted to a wall or ceiling only as recommended by the manufacturer.

17. Power Sources - The appliance should be connected to a power supply only of the type described in the operating instructions or as marked on the appliance.

18. Object and Liquid Entry - Care should be taken so that objects do not fall and liquids are not spilled into the enclosure through the openings.

19. Servicing - The user should not attempt to service the appliance beyond that described in the operating instructions. All other servicing should be referred to qualified service personnel.

Precautions:

1. Power – WARNING, BEFORE TURNING ON THE POWER FOR THE FIRST TIME, READ THE FOLLOWING SECTION CAREFULLY. The amplifier is designed for use only with the line cord of the region in which it will be operated.

2. Voltage Label (Rear Panel) – A label located at the rear panel power connection indicates the AC power input for the unit. The label will read 100-240V AC 50-60Hz 210W Auto-switching.

3. Do Not Plug in the input, output, ethernet, USB or RS-232 connections while the power switch is switched to the “ON” position.

4. Do Not Touch the PLA DL210NET with wet hands. Do not handle the PLA DL210NET or power cord when your hands are wet or damp. If water or any other liquid enters the PLA DL210NET cabinet, take the PLA DL210NET to qualified service personnel for inspection.

5. Place the PLA DL210NET in a well, ventilated location. Take special care to provide plenty of ventilation on all sides of the PLA DL210NET especially when it is placed in an audio rack. If ventilation is blocked, the PLA DL210NET may over heat and malfunction. Do not expose the PLA DL210NET to direct sun light or heating units as the PLA DL210NET internal components temperature may rise and shorten the life of the components. Avoid damp and dusty places.

6. Care – From time to time you should wipe off the front and side panels and the cabinet with a soft cloth. Do not use rough material, thinners, alcohol or other chemical solvents or cloths since this may damage the finish or remove the panel lettering.

System Overview

Thank you for purchasing the PLA DL210 Digi-Loop™ DSP Induction Loop Amplifier. This is the latest in induction loop technology.

An induction loop system uses a large copper loop, usually run on the floor around the inside perimeter of a room, to transmit electromagnetic signals to a receiving device that picks up the broadcast. One advantage of loop systems over other systems is that listeners with T-coil equipped devices (such as hearing aids or cochlear implants) can pick up the broadcast directly without any additional equipment. Users *without* T-coil devices can use optional loop receivers with earphones or headphones to hear the broadcast. This system helps large or small groups overcome background noise and distance to clearly hear the speaker.

The PLA DL210 features DSP Audio processing with an XLR Digital Input. The Class D amplifier delivers crisp, clear audio making speech more intelligible to the listener. The system technician has control over Mixing, Equalization, Compression Ratio, Phase, and Frequency-shaping parameters. High-current output means good powerful broadcast and listener reception regardless of position in the room.

Features

- DSP Audio Processing
- Digital XLR Input
- Dante Input/Connection (PLA DL210NET-D model only)
- Crestron Control (both models PLA DL210NET, PLA DL210NET-D)
- LCD Screen with Metering
- Ethernet, RS-232, and USB
- Mixing, Equalization, Compression, Phase, and Frequency-shaping
- Crystal-clear Class D amplification
- High output current: 12/10A
- Power-save mode
- Master Gain Control
- Active protection against short circuits
- Phoenix input configurable as microphone input or line input, balanced or unbalanced
- Loop-through Line Output
- Standard 2RU 19" Rack Mount
- Meets ADA / ADAAG Guidelines
- 2 year Warranty

AMPLIFIER APPLICATIONS

- Courtrooms
- House of Worship
- Hearing Assistance
- Conference Rooms

IMPORTANT NOTE ABOUT FRONT DISPLAY SCREEN CARE

The Front Display should be cleaned with a clean, damp microfiber cloth only. This will prolong the life and legibility of the screen. Do not use Windex or any other type of cleaner or cloth/paper towel on the screen.

Crestron Control

Both the PLA DL210NET and PLA DL210NET-D models provide the capability of Crestron control - provided the firmware of the unit is at version 1.144 or greater. For instructions on how to upgrade the firmware of the loop amplifier, please see the section in this manual "Upgrading Firmware".

For a full description of the **control and status functions** provided in the the Crestron Module, please visit our website and download the white paper entitled "Crestron® control on the PLA DL210NET and PLA DL210NET-D Loop Amplifiers".

To download the module, visit Crestron's website and download the Williams Sound PLA DL210NET Loop Amplifier control module.

Dante Audio Input

The PLA DL210NET-D model provides a Dante RJ-45 network jack. To change the parameters of Dante (i.e. IP address, Dante Device Name) you must use the Dante Controller software on a PC. The Dante parameters can be viewed, but cannot be set, on the front LCD Display on the loop amplifier (or PC App). For more information on configuration and usage of *Dante Controller*, please visit Audinate's website at: <https://www.audinate.com/products/software/dante-controller>.

With the addition of the Dante jack, two digital audio sources can be connected to the amplifier - Dante or AES/EBU. Dante and AES/EBU cannot be used simultaneously. On the front of the amplifier, or in the PC App, the digital inputs Dig In L and Dig In R are both internally switched between Dante or AES/EBU.

Note: Dig In L and Dig In R are separate channels of audio. They can be used, for example, if two different audio programs are desired, Dig In L could be routed to one loop and Dig In R routed to the other loop. The mixer functions would be used to route each channel to the desired loop. See the section "Input Configuration" for more information about configuring these inputs.

Amplifier Controls and Connectors

Figure A: Front Panel

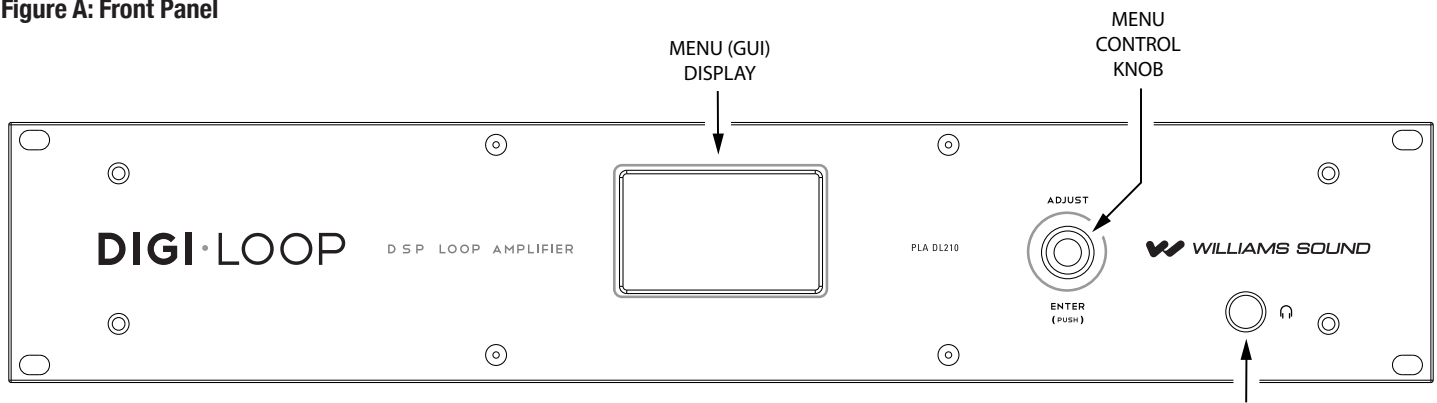
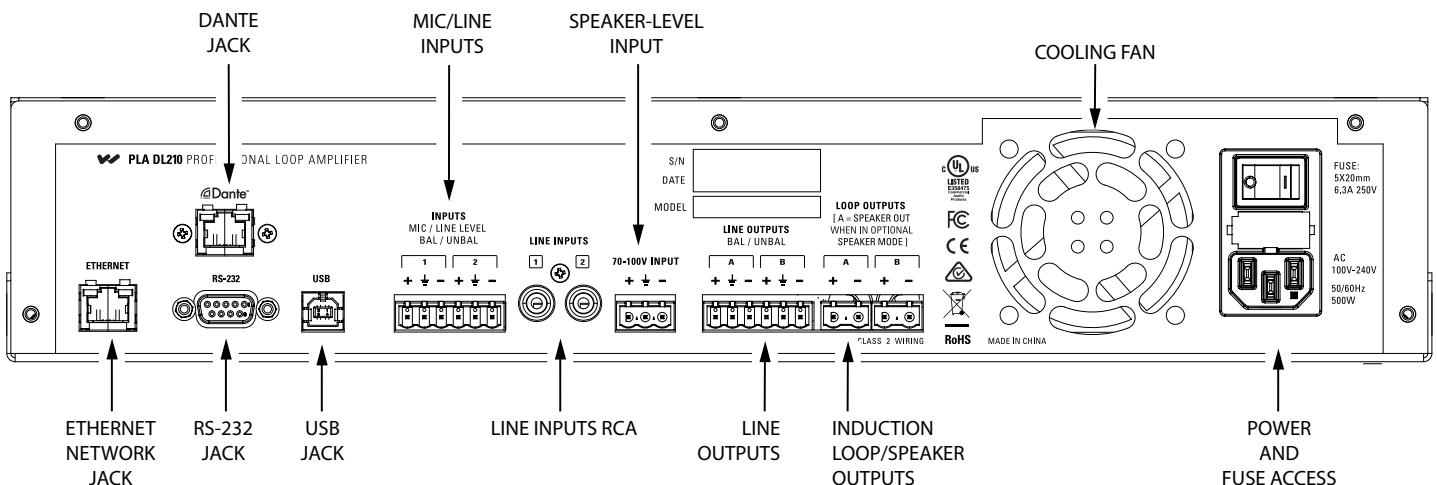
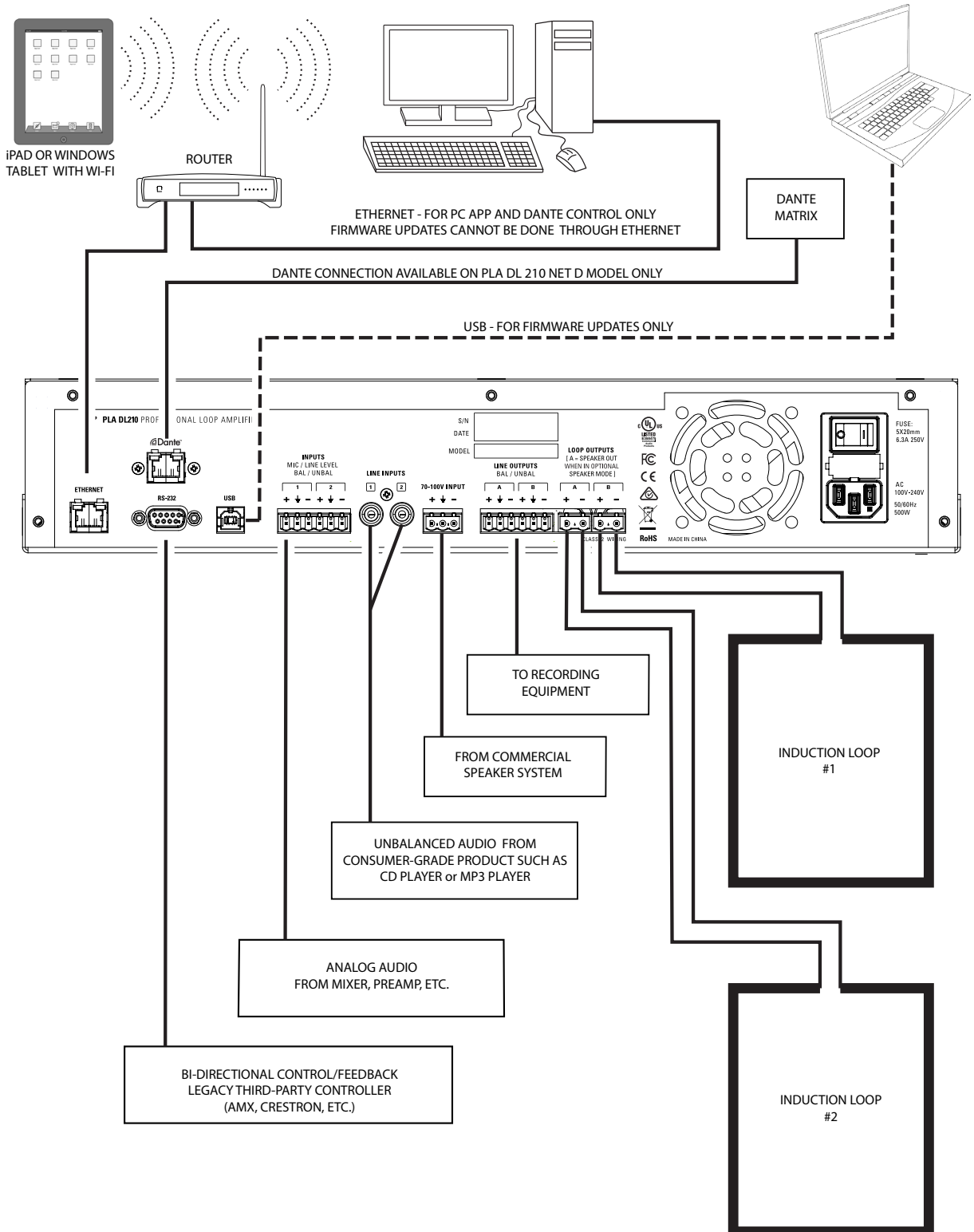

Figure B: Rear Panel



Typical Connections and Installation

Figure C: Example Connections



Rack Installation

1. Install into a 19" rack using 10-32 rack screws.
2. Leave 1U rack space above for ventilation.
3. A surge protector or power conditioner is highly recommended.
4. Use a grounded outlet.
5. Connect all input/outputs before applying power.
6. Plug in the power cord and turn on the unit.

USB Cable Wiring

A standard USB cable (USB Male A to Male B) can be used to connect a computer (such as a laptop) to the Loop Amplifier directly for initial configuration. No drivers are necessary, simply plug-in a USB cable, open the PC App, specify USB connection, and the PC App can be used to change settings on the amplifier. *Note: Firmware upgrades can only be done through the USB connection.*

Ethernet and Dante Cable Wiring

If connecting directly from a Computer to the Loop Amplifier, an Ethernet Crossover Cable must be used.

If connecting through a network, a standard ethernet cable must be used to connect the Amplifier to the network, and a standard ethernet cable must be used to connect the Computer to the network.

If a third party controller will be used (Crestron, AMX, Extron, etc.), a standard ethernet cable can be used to connect the amplifier and controller to the network.

Note: A standard ethernet cable is terminated with either T568A pinout on both ends, or T568B pinout on both ends. A crossover cable has T568A pinout on one end, and T568B pinout on the other end. See the internet for more information on terminating ethernet cables.

RS-232 Cable Wiring

This is required if the third-party controller (Crestron, AMX, Extron, etc.) only has RS-232 control available (no ethernet). The diagram below is for making a custom RS-232 control cable. The only pins required are 2, 3 and 5. Pins 2 and 3 are reversed from one end to the other - so that "receive" on connector 1 is connected to "transmit" on connector 2, and "transmit" on connector 1 is connected to "receive" on connector 2. This circuit facilitates 2-way communication between the third-party controller (Crestron, AMX, Extron, etc.) and the PLA DL210. See Figure D.

Figure D: RS-232 Standard Cable Pinout Configuration

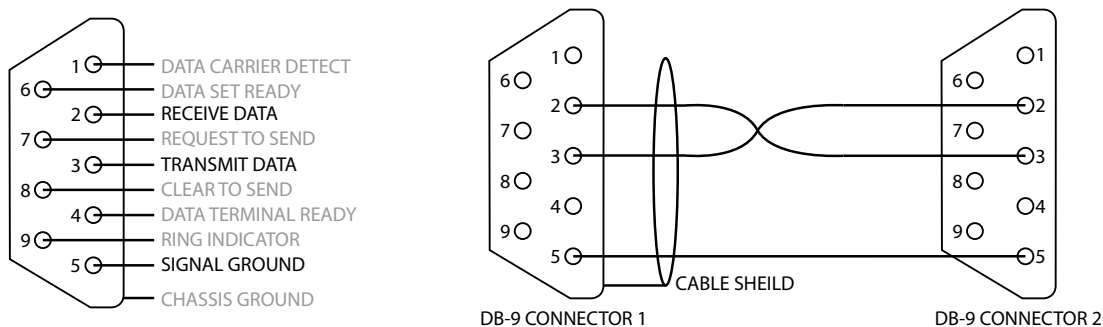

Loop Wire Selection





To select the proper wire for the loop(s), refer to the following chart. Wire resistance of each loop needs to be 0.5 - 1.5 Ω as required by the amplifier.

Wire type	AWG (CSA)	DC Ω 1000 ft (305 m)	Max length (DL107/207) Approx ft	Min length (DL107/207) Approx ft
Single conductor	18 (0.82 mm ²)	6.5	231 (70 m)	77 (23 m)
	16 (1.3 mm ²)	4.3	349 (106 m)	116 (35 m)
	14 (1.9 mm ²)	2.8	535 (163 m)	179 (55 m)
	12 (3.3 mm ²)	1.9	790 (240 m)	263 (80 m)
Flat 3/4" copper	~14 (1.9 mm ²)	2.4	725 (221 m) *	208 (64 m) **

* Flat copper wire is more efficient than single conductor stranded wire at audio frequencies. This allows the maximum length to be greater than the length calculated using the DC resistance. ** In order to present a minimum resistance of 0.5 Ω to the amplifier, the DC resistance must be used.

Setup and Calibration Procedure

If one is already familiar with loop systems, these steps can be used to get the amplifier up and running fairly quickly. A Field Strength Meter is required to perform this procedure. This is one example of calibration, as it could also be performed with an iPad or laptop wirelessly (requires more steps).

1. The DC resistance of the loop should be between 0.5 – 1.5 Ohms.
2. Download and Install the PC Mixer App on the tablet/desktop computer/laptop that will be used to configure the PLA DL210NET. To download the PC App, go to www.williamssound.com/catalog/pla-dl210net and click on the “Downloads” tab. After installation an icon  will appear in the program directory.
3. With the amplifier off, connect the computer to the PLA DL210NET with a standard USB cable.
4. Open the PC Mixer App on the computer.
5. In the PC App, under the Settings tab  on the top toolbar, set the “AmpConnection” to be “USB”, and set “ConnectAction” to “GetMixerState”.
6. Power ON the PLA DL210NET. When the amplifier is done starting up, the VU meters will show on the LCD Display.
7. Click on the amplifier symbol on the top left corner. It should turn green, indicating the computer is now connected to the amplifier. The sliders and VU meters on the PC App should move when the amplifier connects to the computer, indicating that the computer has pulled the current state information from the amplifier.
8. In the PC App, choose the Loop Mode: Dual-Loop, Phased Array, or Speaker (lower right corner above the Output VU Meters. Note that for a single loop, “Dual-Loop” mode should be selected.
9. Connect Loop A and Loop B to corresponding outputs on the back of the PLA DL210NET. If using a single loop, connect it to Loop A. If using a Phased Array, connect the Master loop to Loop A and the Slave loop to Loop B. If using a speaker, connect it to the Loop A Output and the loop wire to Loop B.
10. Run a loop test to make sure the amplifier sees the loop(s) correctly and that there are no breaks in the loop wire(s). The loop test is the  symbol on the top toolbar. Loop test results show up in the status area just below the Output VU Meters (bottom right).
11. Calibrate the loop amplifier to the loop(s). To do this, open the calibrate window  (toolbar). If using a speaker, skip to step 15.
12. Start with Loop A. Make sure the frequency is set to 1kHz. With a field strength meter set appropriately, measure the field strength in the center of the loop at about waist height. Adjust the Volume in the calibrate window until the field strength meter shows 0dB (reference level). This should be 400mA/m.
13. If calibrating Dual Loops, repeat step 12 for Loop B.
14. If calibrating a Phased-Array, **observe the “Average Current”** level in the calibrate window for Loop A. Click on the Loop A button to switch to Loop B in the Calibrate Window, and turn the offset up until the **average current for Loop B matches what you observed for Loop A**. Click on the Loop B button to observe the current for both loops-they should be close. Go to step 16.
15. If calibrating a loop in “speaker” mode, Loop B is the only output that can be calibrated. Make sure the frequency is set to 1kHz. With a field strength meter set appropriately, measure the field strength in the center of the loop at about waist height. Adjust the Volume in the calibrate window until the field strength meter shows 0dB (reference level) for Loop B. This should be 400mA/m.
16. Best Practice Step A: Equalize the other frequencies as best you can to meet the level you have at 1kHz. To do this, run each test frequency one at a time from the calibrate window beginning with 500Hz. Do not adjust the volume. With the Field Strength meter, measure the field strength at each test frequency, and observe how many dB the signal strength is from 0dB. Write them down.
17. Best Practice Step B: Open the Output Effects Window for the Loop Output being used. For the test frequencies in step 16, adjust the Bass, Midrange, Treble or Metal Compensation by the values you wrote down in step 16 to compensate for low or high points in the frequency response. The goal is to get the frequency response ± 3 dB from 0dB (1kHz reference), from 100 Hz to 5kHz to meet the IEC 60118-4 Specification.
18. In the Output Effects Window: If the loop will be used for speech, choose the “Voice” preset for the Automatic Gain Control. If a source like music will be used, choose the “Music” preset. The Voice preset is designed for pauses in the audio, while the Music preset is designed for more continuous audio sources. If more fine-tuning of the AGC is needed, the Custom Preset can be used to obtain access to the Hold Time, Attack, and Release adjustments.
19. Configure the input types; i.e. condenser vs electret mic, using the Trim and Line buttons. When this has been done, power OFF the amplifier, connect the microphones and other inputs, and power the amplifier back ON.
20. Reconnect the computer/amplifier by clicking on the amplifier symbol (top left). Now use the PC App to adjust the inputs as you would a normal mixer. When set correctly, the overall output (bottom right VU meters) should pulse to around 0dB on average.
21. Once all of these adjustments have been finalized, use a loop receiver such as the Williams Sound PLR BP1 or PLR SR1 to listen to the loop(s). After this test is successful, have someone with a T-Coil equipped hearing-aid (or T-Coil equipped cochlear implant) also listen to the loop(s). The audio should be clear and intelligible.

Single Perimeter Loop Configuration using front LCD (Dual Loop Mode)

1. Define the area needed for the loop layout.
2. DC resistance of the loop and lead wire should be between 0.5 and 1.5 Ohms.
3. Connect loop wire to the DL210 Phoenix connector and insert to Loop Output A.
4. Connect all inputs to be used into the DL210.
5. Turn the power on.
6. Rotate the menu knob clockwise and go to the configuration menu. Push knob in (click) to enter and select output configuration. Turn the rotary selector to Loop A. Scroll to set-up, click and select loop mode. Select dual loop and click to store setting.
7. Going back to the Configuration Menu, select System Configuration page in the menu and select tech tools, then select calibrate. Scroll down to the frequency, click and select 1 kHz.
8. With the field strength meter set appropriately, measure the field strength at the mid-point of the loop. Adjust the volume (one step down in the calibrate page) until the field strength measures 0dB (400m/A) in the center of the looped area.
9. This field strength setting should be 400 mA/m \pm 3 dB at any point within the loop area to meet the IEC 60118-4 standard.
10. Back out of calibrate/system configuration menu. The input to the amplifier should now be adjusted to an acceptable input level.

To meet the **IEC 60118 Standard**:

Field strength: 400mA/m peak response at 1kHz (Calibration Point)

Frequency response: 100 - 5000Hz \pm 3 dB relative to 1kHz Calibration Point (achieved through Equalization)

Note: The lead length from the amplifier to the loop should be kept as short as possible.

Note: The amplifier must be calibrated to the loop before adjusting the Output Effects.

Figure E: Single Loop Concept

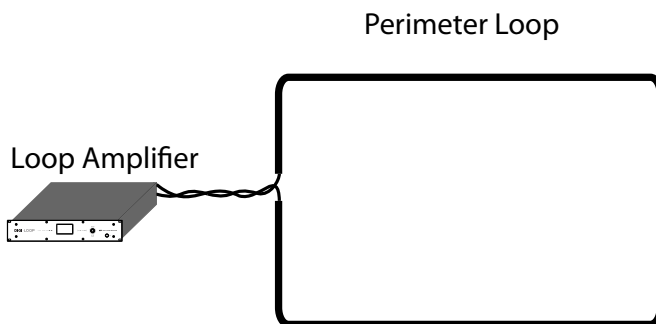

Dual Loop Calibration using front LCD (Dual Loop Mode)

Note: this mode is also used for a single loop; in this case steps referring to Loop B can be skipped.

1. Define the areas needed for the loop layout.
2. DC resistance for each separate loop with lead wire should be between 0.5 and 1.5 Ohms.
3. Connect loop wire to the DL210 Phoenix connectors and connect to Loop Outputs A and B.
4. Connect all inputs to be used into the DL210.
5. Turn the power on.
6. Rotate the menu knob clockwise and go to the configuration menu. Push knob to enter and select output configuration and turn rotary selector to Loop A. Scroll to set-up, click and select loop mode. Select dual loop and click to store setting.
7. Going back to the Configuration Menu, select System Configuration page in the menu and select tech tools, then select calibrate. Scroll down to the frequency, click and select 1 kHz.
8. With the field strength meter set appropriately, measure the field strength at the mid-point of the loop. Adjust the volume (one step down in the calibrate page) until the field strength measures 0dB (400mA/m).
9. Rotate the menu knob clockwise and go to the configuration menu. Push knob to enter and select output configuration and turn rotary selector to Loop B. Scroll to set-up, click and select loop mode. Select dual loop and click to store setting.
10. Going back to the Configuration Menu, select System Configuration page in the menu and select tech tools, then select calibrate. Scroll down to the frequency, click and select 1 kHz.
11. With the field strength meter set appropriately, measure the field strength at the mid-point of the loop. Adjust the volume (one step down in the calibrate page) until the field strength measures 0dB (400mA/m) with a field strength meter.
12. This field strength reading should be 400 mA/m \pm 3 dB at any point within the loop area to meet the IEC 60118-4 standard.

To meet the **IEC 60118 Standard**:

Field strength: 400mA/m audio peak response at 1kHz (Calibration Point)

Frequency response: 100 - 5000Hz \pm 3 dB relative to 1kHz Calibration Point (achieved through Equalization)

Note: The lead length from the amplifier to the loops should be kept as short as possible.

Note: The amplifier must be calibrated to the loops before adjusting the Output Effects.

Figure F: Dual-Loop Concept

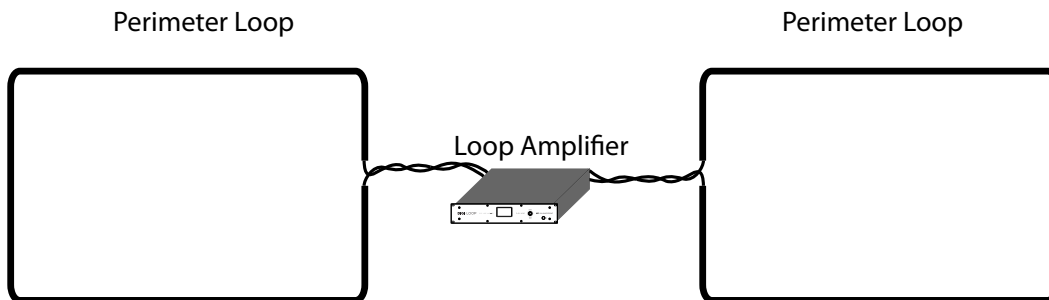

Phased-Array Calibration using front LCD (Phased Array Mode)

1. Master and Slave loop wire layout should follow parameters defined by blueprints and site survey findings.
2. Loop wire and lead wire DC resistance should be between 0.5 and 1.5 Ohms on both the Master and Slave loops.
3. Connect the Master Loop wire to the DL210 Phoenix connector and connect to Loop Output A.
4. Turn the power on, rotate the menu control clockwise and go to the configuration menu. Push the menu control to enter and select output configuration and rotate menu control to Loop A. Scroll to set-up, click and select loop mode. Select Phased Array and click to store setting.
5. Access System Configuration/tech tools/calibrate screen. Set the frequency to 1kHz and set the output level to Loop Output A until it meets 400mA/m (using the field strength meter) at the center of the looped area. The current in the Master (A) should be measured and then duplicated for the slave loop (B).
6. Connect the Slave Loop wire to the DL210 Phoenix connector and connect to Loop Output B. Adjust the current into Slave loop to match the Master Loop.
7. Turn the power off.
8. Connect all inputs to be used into the DL210.
9. Turn the power on.
10. This field strength at 1kHz should be 400 mA/m \pm 3 dB at any point within the loop area to meet the IEC 60118-4 standard.

To meet the **IEC 60118 Standard**:

Field strength: 400mA/m audio peak response at 1kHz (Calibration Point)

Frequency response: 100 - 5000Hz \pm 3 dB relative to 1kHz Calibration Point (achieved through Equalization)

Note: The lead length from the amplifier to the loops should be kept as short as possible.

Note: The amplifier must be calibrated to the loops before adjusting the Output Effects.

Figure G: Phased-Array Concept

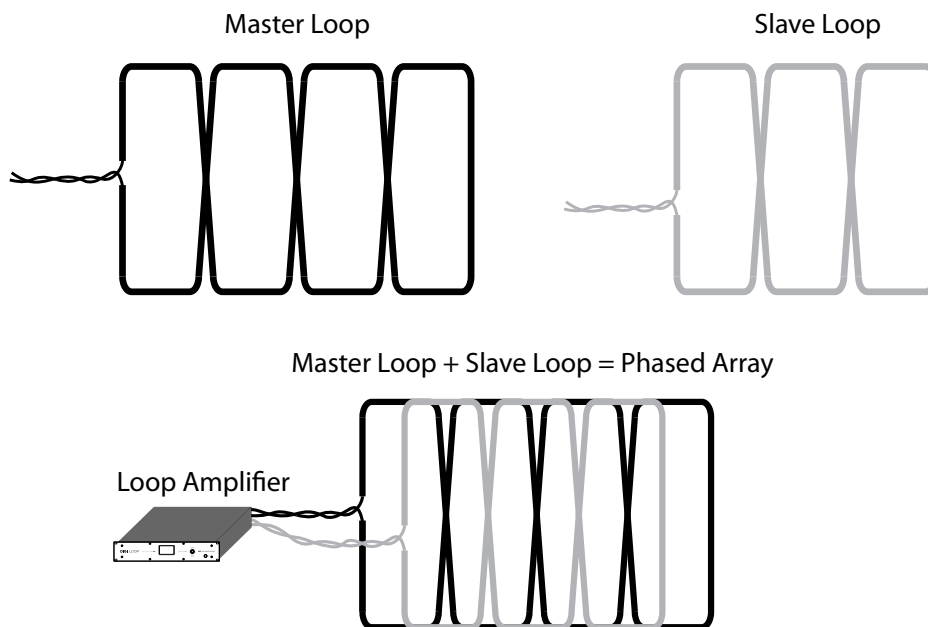

One Speaker + Single Loop Calibration using front LCD (Speaker Mode)

1. Define the area needed for the loop layout.
2. Loop and lead in wire DC resistance should be between 0.5 and 1.5 Ohms.
3. Connect loop wire to the DL210 Phoenix connector and insert to Loop Output B.
4. Turn the power on.
5. Rotate the menu knob clockwise and go to the configuration menu. Push knob to enter and select output configuration and turn rotary selector to Loop A. Scroll to set-up, click and select loop mode. Select speaker/loop and click to store setting.
6. Going back to the Configuration Menu, select System Configuration page in the menu and select tech tools, then select calibrate. Scroll down to the frequency, click and select 1 kHz.
7. With the field strength meter set appropriately, measure the field strength at the mid-point of the loop. Adjust the volume (one step down in the calibrate page) until the field strength measures 0dB (400m/A) on the field strength meter.
8. This field strength setting should be 400 mA/m \pm 3 dB at any point within the loop area to meet the IEC 60118-4 standard.
9. Turn the power off.
10. Connect speakers to Output A. Speaker Impedance should not be below 4 Ohms.
11. Turn the power on.

To meet the **IEC 60118 Standard**:

Field strength: 400mA/m audio peak response at 1kHz (Calibration Point)

Frequency response: 100 - 5000Hz \pm 3 dB relative to 1kHz Calibration Point (achieved through Equalization)

Note: The lead length from the amplifier to the loop should be kept as short as possible.

Note: The amplifier must be calibrated to the loop before adjusting the Output Effects.

Figure H: Speaker and Single Loop Concept

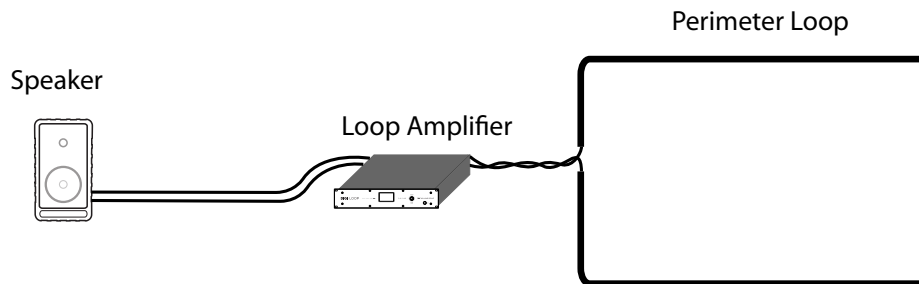

Front LCD Screen Menu Tree

The following is an overview of the on-screen menu. The numbers by each block refer to the Front Menu Detail Section (next page).

Figure I: Front Screen Menu Tree

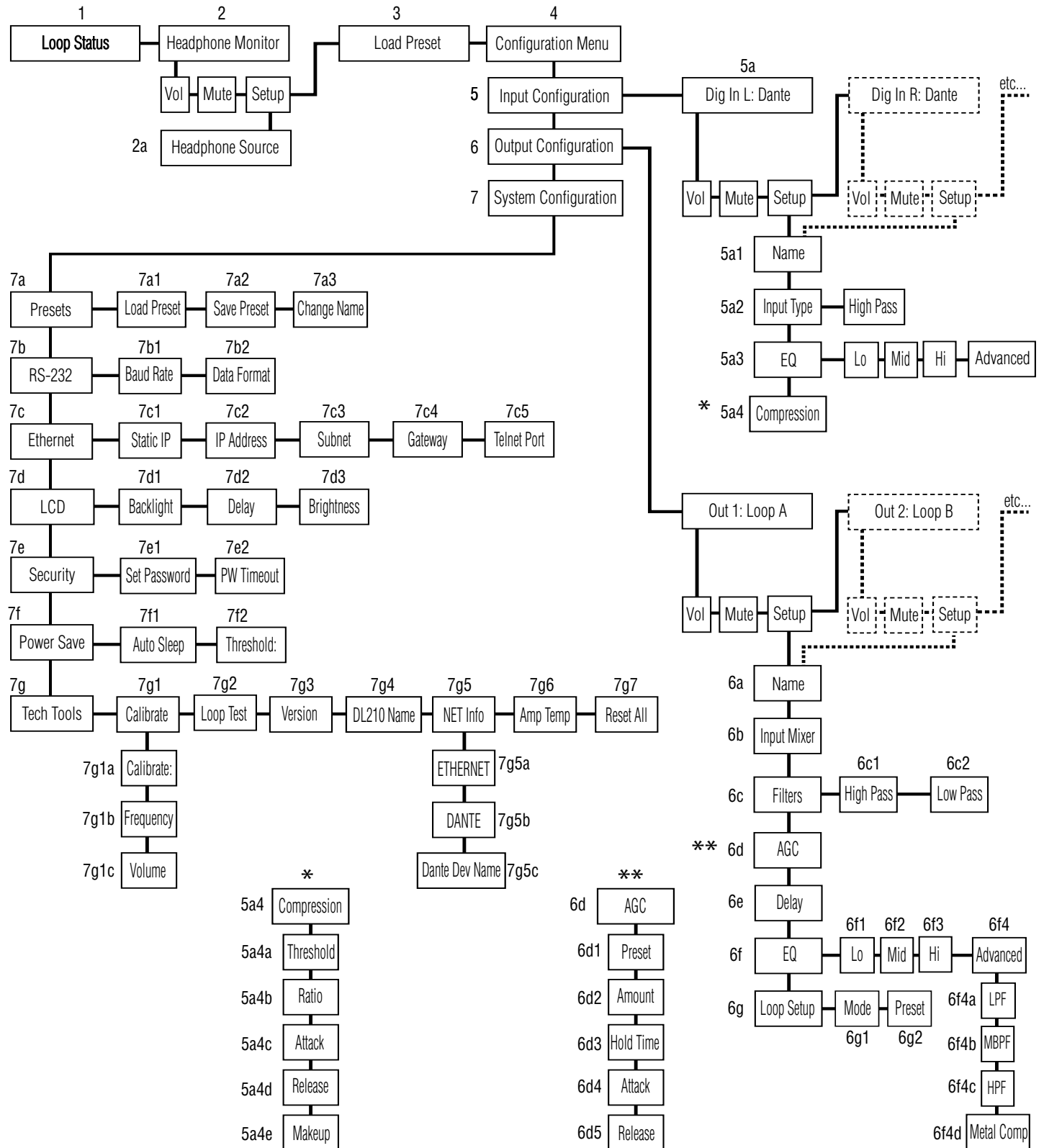

Front Menu Detail

The entire on-screen menu is accessed by either rotating the control knob to the left or right (to view), or pushing it in (to select).

See the Menu Tree (previous page) for an overview of the entire menu structure.

1. LOOP STATUS

The On-Screen Menu starts, and when it times-out, will return to the “Loop Status” Screen (below). The bars represent the power output of the loop(s), and will pulse with the audio program being broadcasted on the loop (or speaker). The vertical lines going through the bars represent the reference level of 0dB.

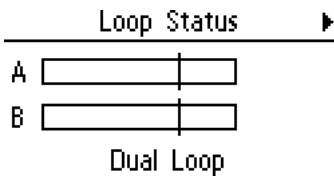

2. HEADPHONE MONITOR

The Headphone monitor can be used to listen to any individual source or output, or to listen to adjustments as they are made in the menu. Rotate the knob once to the right to see the Headphone Monitor screen. The vertical bar going through the bar graph represents a reference level of 0dB. You can change the volume of the headphones or mute the audio from this screen. To change the headphone source, enter the setup.

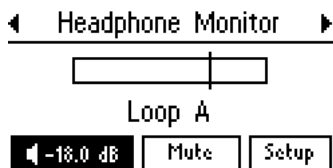

2a. Headphone Source

To change the headphone source, enter the Headphone Monitor Setup. Rotate the knob to view the sources. Push the knob in to select the source you want to hear through the headphones.



3. LOAD PRESET

Presets provide the ability to save and recall custom configurations (all amplifier settings). This is where a preset can be recalled, or “loaded”. To save a Preset, see 7a2.

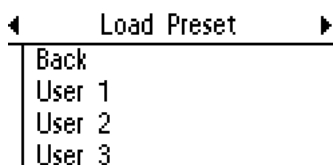

4. CONFIGURATION MENU

The configuration menu is where most of the amplifier settings and fine-tuning is performed. This menu is where Inputs and Outputs are configured and system parameters are set up, stored and recalled.

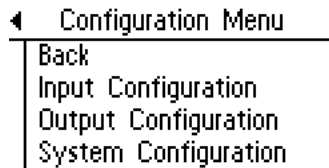

5. INPUT CONFIGURATION

Each of the inputs can be configured individually. To set up Input 1, enter “Input Configuration”. Input 1 is the first input you can adjust, so it is already selected. Rotate the knob to get to “Setup” and push the knob to enter setup.

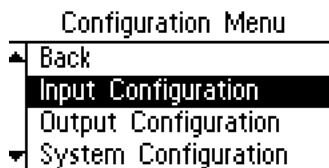

5a1. Name

This allows you to name the Input. To change the name, select the first character and rotate the dial to change letters/numbers. When the character you want is displayed, push the knob in to select that character and move to the next position. When finished with the last character of the name, rotate knob until “OK” is highlighted; then push the knob in to save the name.

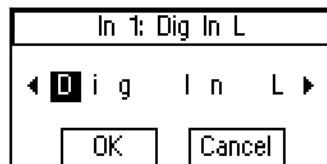
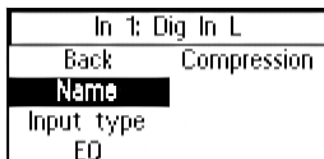

5a2. Input Type

The options for input type depend on which input you are setting up. For the “Dig In L” input (shown below), the only adjustment is a High Pass Filter crossover point (frequency) and attenuation. If setting up the Mic/Line inputs, the 3-pin Phoenix Connector can be programmed to accept various levels: Line +4dBu, Line +8dBu, Line -10dBV, or Microphone. 48v Phantom Power is automatically turned on when “Microphone” is selected. Before using a microphone, check the owner’s manual specifications about the use of phantom power. Note: The “Dig In L” and “Dig In R” inputs switch together, and both inputs are either AES or Dante. For example, when “Dig In L” is switched from AES to Dante, the “Dig In R” input follows and switches to Dante. These inputs can be switched here, or in the PC App (see the section “Using the PC Mixer Application” - “PC App Main Screen” - “Digital Input Switch”).

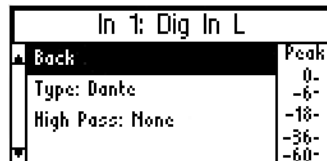
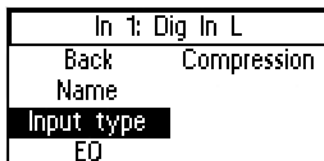

5a3. EQ

This is a 3-band parametric equalizer providing adjustment for Low, Mid-Band, and High frequency. The center or cutoff frequency for each band is chosen under the Advanced Settings. The first screen (below) shows the level adjustment for each of the bands (midrange highlighted). Rotate the knob until Advanced Settings is highlighted and push the knob to select. The 3rd screen (below) shows the advanced settings, where the center or cutoff frequency for each of the bands is chosen as well as the slope (in dB) of the cutoff.

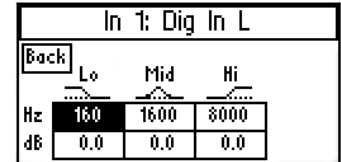
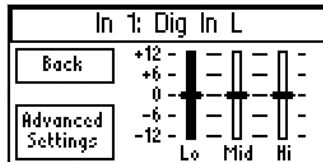
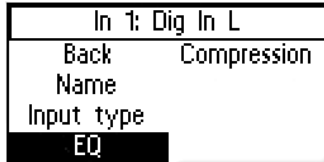

5a4. Compression

Compression reduces the dynamic range of the input/output, making soft sounds louder and loud sounds quieter. It has the overall effect of “volume levelling” so the entire program is more intelligible to the listener. Compression has 5 adjustable parameters: Threshold, Ratio, Attack, Release, and Makeup Gain.

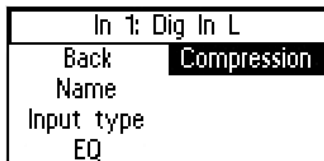

5a4a-e. Threshold, Ratio, Attack, Release, Makeup

Threshold is the level of incoming signal at which compression takes effect. The Threshold is adjustable from -96.0dB to 0.0dB in 0.5dB steps.

Ratio determines how much compression is applied when it takes effect. The Ratio is adjustable from 1.0:1 (no compression) to 10.0:1 in 0.1 steps.

Attack is the speed at which compression reacts when the input signal crosses the threshold. The Attack is adjustable from -0ms to 500ms in 2ms steps.

Release controls the time that the compressor continues to work after the input signal drops beneath the threshold. Short settings release the signal quickly, while long release times have the effect of sustaining the signal. The Release is adjustable from 0ms to 2500ms in 10ms steps.

Makeup Gain is used to bring the overall level of the sound back up, when the overall volume has been reduced by compression. This happens when the threshold is set low and/or the ratio has been set high. The Makeup Gain is adjustable from 0dB to 40dB in 0.5db steps.

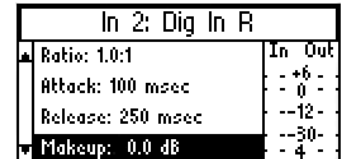
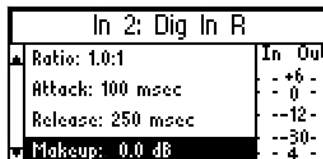
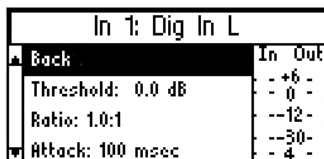

6. OUTPUT CONFIGURATION

Each of the outputs can be configured individually. To set up Output 1, enter “Output Configuration”. Output 1 is the first input you can adjust, so it is already selected. To get to the next input, rotate the knob to the right.

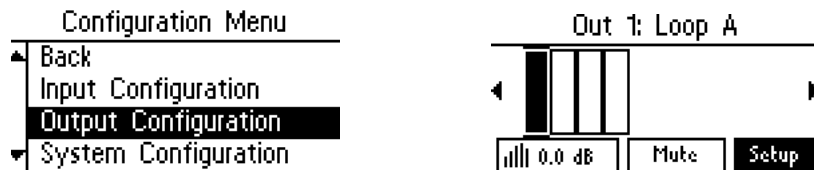

6a. Name

This allows you to name the Output. To change the name, select the first character and rotate the dial to change letters/numbers. When the character you want is displayed, push the knob in to select that character and move to the next position. When finished with the last character of the name, rotate knob until “OK” is highlighted; then push the knob in to save the name.



6b. Input Mixer

The Input Mixer provides level adjustment of each of the inputs per each output. This is used when one (or more) input(s) may be louder or softer than the others. You can use the headphones plugged into the headphone jack to monitor the adjustments.



6c1-2. Filters

Filters provide adjustment for a high pass filter and low pass filter crossover frequency.

The High Pass Filter has crossover points at: Off (None), 31Hz, 62 Hz, 125 Hz, and 500 Hz.

The Low Pass Filter has crossover points at: Off (None), 16 kHz, 8 kHz, and 6.3 kHz.

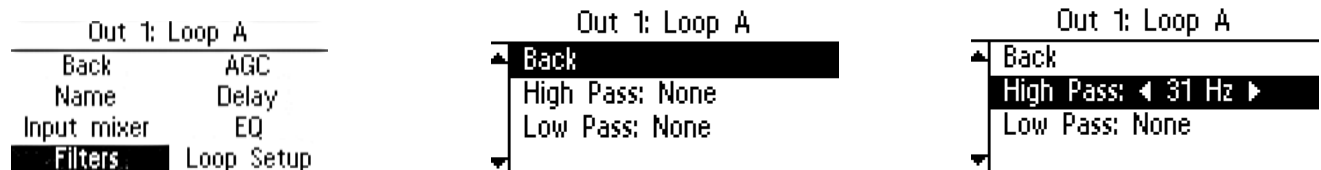

6d. AGC

Automatic Gain Control measures the average level of the signal and applies gain reactively to keep the output level constant. It also limits the output power and reduces or eliminates distortion due to clipping that would normally occur without AGC.

Out 1: Loop A	
Back	AGC
Name	Delay
Input mixer	EQ
Filters	Loop Setup

6d1-6. AGC Level, Hold Time, Attack, Release

Preset provides default settings for Voice and Music, and only the Amount is adjustable. A Custom preset allows adjustment of the Hold Time, Attack, and Release. Voice is designed for pauses in the audio, where Music is designed for more constant-level sources.

Amount of the AGC can be adjusted to a maximum of 20dB of around the calibrated level, or “target” level. For people familiar with traditional AGC, the Target is internally set to the calibrated level and is not adjustable, and the Minimum Level (also called “Threshold”) is internally set relative to the calibration target level and is not adjustable. The calibrated “target” level is set in Tech Tools-Calibrate, and this is the level the AGC will attempt to hold.

Hold Time is how long the gain is maintained on signal when the automatic gain settings take effect. In the Custom preset, the Hold Time is adjustable from 1 second to 60 seconds in 1 second steps.

Attack is the speed at which the AGC reacts when the level of the input signal crosses the threshold. Short settings react to the signal quickly, while long attack times have a lagging effect. In the Custom preset, the Attack time is adjustable from 0.5 s to 3.5 s in 0.5 s steps.

Release is the amount of time that the AGC continues to work after the input signal drops beneath the threshold. Short settings release the signal quickly, while long release times have the effect of sustaining the signal. In the Custom preset, the Release time is adjustable from 0.5 s to 3.5 s in 0.5 s steps.

Out 1: Loop A	
▲ Preset: ◀ Custom ▶	
Amount: 7	
Hold Time: 10 sec	
▼ Attack: 0.1 sec	

Out 1: Loop A	
▲ Amount: 7	
Hold Time: 10 sec	
Attack: 0.1 sec	
▼ Release: 2.5 sec	

6e. Delay

Delay is the amount of time between the input signal and the output signal of the amplifier. This is often useful in a loop system when a PA system is also being used, so that the audio being heard through the loop (receiver or hearing aid) matches that of the PA System speakers. Delay helps to eliminate this “echo” effect. The Delay is adjustable from 0 ms to 165 ms in 1 ms steps.

Out 1: Loop A	
Back	AGC
Name	Delay
Input mixer	EQ
Filters	Loop Setup

Out 1: Loop A	
▲ Back	
Delay: 0 msec	
▼	

6f1-3. EQ - Lo, Mid, Hi

The EQ is a Parametric Equalizer. In the basic settings (second screen, below), there is a low, mid-band, and high frequency slider that can be adjusted between -12 dB and 12 dB. To review or change the pole frequencies, see “6f4a-d. Advanced Settings”, below.

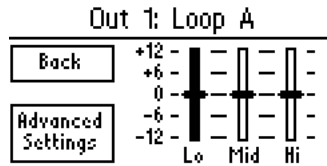
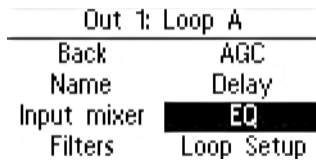

6f4a-d. Advanced Settings - Lo, Mid, Hi, Metal Comp

Advanced Settings provide the ability to change the frequency point, define a more specific numerical dB level, or adjust for high-frequency metal loss. The Lo, Mid, and Hi filters can all be adjusted from 20 Hz to 20kHz, and -12 dB to +12 dB. The Metal Compensation can be adjusted from 1kHz to 9kHz, and -12dB to +12 dB.

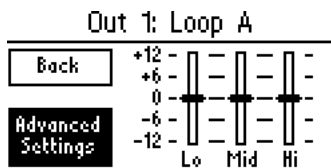

Out 1: Loop A

Back	Lo	Mid	Hi	Metal Comp
Hz	160	1600	8000	4000
dB	0.0	0.0	0.0	0.0

6g. Loop Mode

Loop Mode configures the outputs for different loop/speaker combinations. Use **Dual-Loop mode** to drive a single loop or two single loops (not overlaid, no phase shift). Use **Phased Array mode** for two overlaid loops in a phased array layout (where 90° phase-shifting is needed). Use **Speaker mode** if output A will be used to drive a speaker, and output B will drive a loop or be left open.

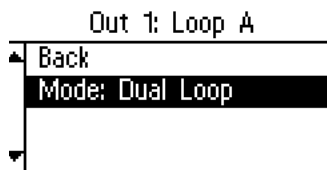
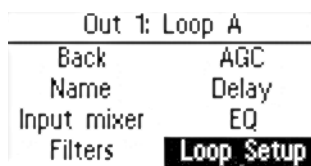

7. SYSTEM CONFIGURATION

7a1-3. Presets - Load Preset, Save Preset, Change Name

Presets allow the user to store all of the current amplifier settings into one easy-to-access Preset, and recall the Preset when needed. These presets are stored in the amplifier (not to be confused with saving or loading a configuration file, which can only be done through the PC App and is stored on a computer). Three presets are available as a starting point, with defaults, as shown - Dual-Loop, Phased-Array, and Speaker/Loop. There are also three Custom Presets available - User 1, User 2, and User 3. The User Presets can be renamed. The Dual-Loop, Phased Array and Speaker/Loop Presets cannot be altered or saved; they can only be loaded.

We recommend saving the settings in a User Preset in case of power outage or other catastrophic failure. Settings should be saved immediately after the system is calibrated.

System Configuration	
Back	LCD
Presets	Security
RS-232	Power Save
Ethernet	Tech Tools

System Configuration	
Back	LCD
Presets	Security
RS-232	Power Save
Ethernet	Tech Tools

Load from:	
Back	User 4
User 1	Dual Loop
User 2	Phased Array
User 3	Speaker/Loop

System Configuration	
Back	
Load Preset	
Save Preset	
Change Name	

Save to:	
Back	User 4
User 1	
User 2	
User 3	

System Configuration	
Back	
Load Preset	
Save Preset	
Change Name	

Change name of:	
Back	User 4
User 1	
User 2	
User 3	

Change name of:	
◀	U s e r 1 ▶
OK	

Change name of:	
Put preset on front menu?	
Yes	No

Change name of:	
User preset 1 renamed.	
OK	

7b. RS-232

This allows the user to configure the RS-232 communication settings. These settings are determined by the 3rd party controller being used to control the amplifier.

Important! If changing the baud rate, the amplifier must be powered Off, then On, for the new baud rate to take effect!

System Configuration	
Back	LCD
Presets	Security
RS-232	Power Save
Ethernet	Tech Tools

System Configuration	
Back	
Baud rate: 9600	
Data format: 8-N-1	

System Configuration	
Back	
Baud rate: 9600	
Data format: ◀ 8-N-1 ▶	

7c. Ethernet

Ethernet settings provides the ability to choose dynamic IP addressing or specify a static IP Address for the amplifier. The amplifier's default state is dynamic (DHCP). **If using DHCP** (choosing "No" for Static IP in the second screen below) **you need to go to a different screen to find out what the assigned IP Address is (See 7g5, IP Address under Tech Tools)**. If using the ethernet connection, the amplifier must be set up through the front screen GUI before a networked or direct-connected PC can communicate with it, and the PC App cannot be used until those settings are made. If direct-connecting a PC through the ethernet connection, a crossover cable must be used, and the amplifier must be in the same IP Address range, and subnet, as the PC. The USB connection can be used if direct-connecting to a PC, and will communicate with the amplifier without a lot of setup; the user just needs to choose USB as the connection in Application Settings (See PC Application Setup).

Important! If changing to a static IP Address, the amplifier must be powered Off, then On, for the new IP address to take effect!

System Configuration	
Back	LCD
Presets	Security
RS-232	Power Save
Ethernet	Tech Tools

System Configuration	
▲ Back	
	Static IP: ◀ No ▶
	IP addr: (dynamic)
▼	Subnet: (dynamic)

System Configuration	
▲ Back	
	Static IP: Yes
	IP addr: 0.0.0.0
▼	Subnet: 0.0.0.0

7d1-3. LCD - Backlight, Delay, Brightness

The front panel LCD screen can be adjusted to have the backlight **always on**, **auto-dim** after a period, **auto-off** after a period, or **always off**. The **backlight delay** determines how long before the auto-dim or auto-off function takes effect. Note that the LCD continues to display information when the backlight is off. The **brightness** of the backlight can be adjusted from 1-10.

System Configuration	
Back	LCD
Presets	Security
RS-232	Power Save
Ethernet	Tech Tools

System Configuration	
▲ Back	
	Backlight: On
	Delay: 30 sec
▼	Brightness: 10

7e1-2. Security - Set Password, Password Timeout

The Security function allows you to set a password and determine the password timeout delay. The 3-digit access password restricts unauthorized configuration changes. The password cannot be recalled or displayed on the screen. The password timeout delay determines how long the amplifier will display the password entry screen.

The password can be reset by starting with the unit off, pushing the knob in and holding it, turning on the amplifier (while continuing to hold the knob in), and waiting until the screen shows "System Password Cleared" (roughly 20 seconds). A reset to factory defaults will also reset the password, but it will also erase all stored presets and system settings.

System Configuration	
Back	LCD
Presets	Security
RS-232	Power Save
Ethernet	Tech Tools

System Configuration	
▲ Back	
	Set configuration PW
▼	PW timeout: 5 min

Enter new password:

- -

7f1-2. Power Save - Auto Sleep, Threshold

The power save function will turn the amplifier off after a period (Auto Sleep Delay) when the input audio level falls below a specified level (Threshold). The **Auto Sleep** delay is adjustable in 10 minute increments from Off (never sleeps, on all the time) to 120 minutes. The **Threshold** is adjustable from -80 dB to -30 dB in 1 dB steps. The default setting is 30 minutes and -80 dB.

System Configuration	
Back	LCD
Presets	Security
RS-232	Power Save
Ethernet	Tech Tools

System Configuration	
▲ Back	
	Auto Sleep: ◀ 30 min ▶
▼	Threshold: -80 dB

System Configuration	
▲ Back	
	Auto Sleep: 30 min
▼	Threshold: ◀ -80 dB ▶

7g. Tech Tools

Tech Tools provides the ability to calibrate the amplifier through use of a test tone, perform an open loop test, check the firmware version(s) of the ICs, name the amplifier, set a static or dynamic IP address, and reset the amplifier to factory default settings.

System Configuration	
Back	LCD
Presets	Security
RS-232	Power Save
Ethernet	Tech Tools

7g1 a-c. Calibrate - Output, Frequency, Volume

Calibrate determines which output to send the test tone to (Loop A or Loop B).

Frequency of the test tone can be set to 100 Hz, 500 Hz, 1 kHz, 2.5 kHz, or 5 kHz.

Volume of the test tone can be adjusted from -96 dB to 0 dB in 1 dB steps.

System Configuration	
Back	DL210 Name
Calibrate	NET Info
Loop Test	Amp Temp
Version	Reset All

System Configuration	
Back	Amps
Calibrate: Loop A	0.1
Frequency: 1 kHz	15
	10
	5
Volume: -50 dB	0

7g2. Loop Test

The Loop Test option performs an open circuit test to verify that a loop is connected. If it finds that a loop is “open” the test will show “FAIL”. Note that when running a single loop in dual-loop mode, a “FAIL” is acceptable for the output with no loop connected. This tool is to verify that a connected loop does not have an open (break) in it.

System Configuration	
Back	DL210 Name
Calibrate	NET Info
Loop Test	Amp Temp
Version	Reset All

System Configuration	
Loop A: Testing	
Loop B: Waiting	
Test	OK

System Configuration	
Loop A: Pass	
Loop B: FAIL	
Test	OK

7g3. Version

Version is an info screen that shows the firmware version of the bootloader chip, main processor chip (CPU), DSP chip#1 and DSP chip #2.

System Configuration	
Back	DL210 Name
Calibrate	NET Info
Loop Test	Amp Temp
Version	Reset All

Firmware version info	
Bootloader: 1.15	
Main CPU: 1.144	
DSP1: 1.142	DSP2: 1.142
OK	

7g4. DL210 Name

The DL210 Name provides the ability to give the amplifier an 8-character name for easy identification when connecting to it through the PC App on a network. This name will show up on a drop-down list in the PC App as an available device to connect to. For example, if 5 amplifiers were connected on the network, and the third amp was designated for the Ballroom, you could connect to “Ballroom” amplifier to make changes to that amp’s settings.

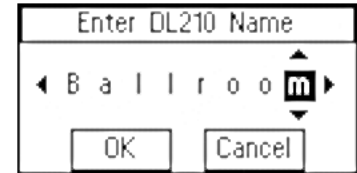
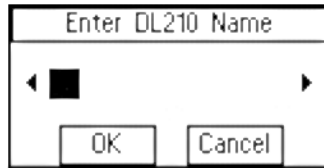
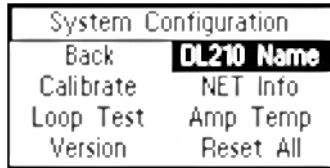

7g5. NET Info

This screen is for viewing Ethernet and Dante parameters of the amplifier. No changes can be made from this screen.

Four parameters can be viewed here: (1) Ethernet Address and MAC address of the ethernet card, (2) Ethernet Address and MAC address of the Dante card, (3) the Dante Card Name, and (4) the Default Dante Card Name. To set the ethernet parameters, see section “7c Ethernet”. To set the DL210 Name, see the previous section “7g4 DL210 Name”. To set the Dante parameters, use **Dante Controller**. (For more information about installing/using Dante controller, please visit Audinate’s website: <https://www.audinate.com/products/software/dante-controller>).

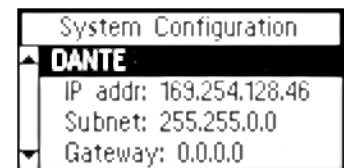
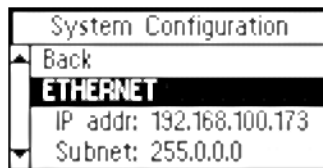
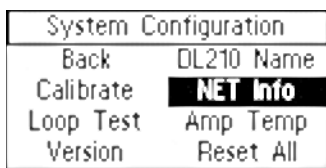

Dante parameters such as IP address cannot be set in the loop amplifier. They are set by Dante Controller. The assigned IP parameters can be viewed here (only).

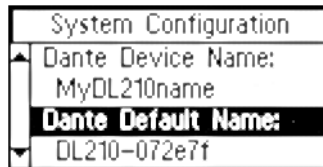

7g6. Amp Temp

The temperature of the two amplifier output stages and the CODEC (audio processor chip) can be monitored here. A “zZ” by the temperature means that the amplifier is in sleep mode (see “7f. Power Save” for how to adjust when the amplifier goes to sleep).

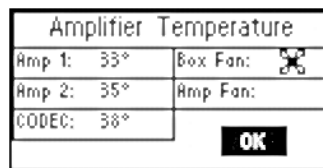
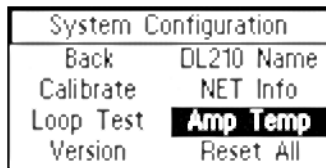

7g7. Reset All

This resets all of the settings back to factory defaults - **except** the Ethernet and Dante Network Settings. Any other user-entered information will be lost. The amplifier may need to be rebooted after the factory reset is performed to change states. For example, if the amplifier goes to sleep it may still be asleep until it gets rebooted.

Note: The PC App gives the user the ability to save all settings to a configuration file for recall later. In this manner, all settings can be erased (here) to bring the amplifier back to a known state (factory defaults) for troubleshooting purposes, etc. Then if desired, a saved configuration can be loaded back into the unit via the PC App. It is good practice to store backup configurations in a configuration file (see PC App section) if much work has been done to finely adjust the amplifier.

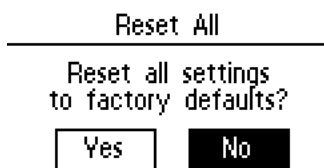
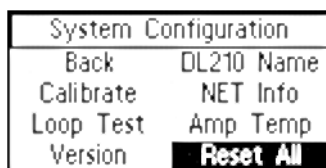

PC Mixer Application and iPad App Initial Setup

SYSTEM REQUIREMENTS

PC App: The PC Mixer App can be used to communicate with the amplifier through the Ethernet, USB, or RS-232 Ports. The ethernet connection is recommended when using the PC App for best performance. The PC App must be configured for the type of connection used before the Computer will communicate with the Loop Amplifier.

The PC App may fail to install, or not work properly, if the following conditions are not met (see chart).

iPad App: To download and install the iPad App, visit the iTunes Store and search for the “PLA DL210”. The loop amp must be on a router with wi-fi and the iPad must be connected to the wi-fi in order to proceed with setup. Set an IP Address in the loop amp and enter the same address in the iPad App to connect. When connected, current status of the amp (such as VU meters and current slider positions) should show up. **The iPad App may fail to install, or not work properly, if the following conditions are not met (see chart).**

Desktop/Laptop Computer	Windows PC. Mac PC not supported.
Mobile Device	Windows Surface Tablet, iPad or iPad Mini. Android not supported.
Operating System Requirements	Windows XP, Windows Vista, Windows 7, Windows 8 (others not supported). Microsoft .NET 4.0.30319 minimum.
	iOS 7.0 or later
Ethernet	10/100 GB; Standard RJ-45 jack.
USB	1.1, 2.0 (12 MBs high speed), 3.0 (5GBs super speed); standard-B jack.

INSTALLING THE PC MIXER APPLICATION

1. To download the PC Mixer Application, please visit our website, go to the PLA DL210NET product page, and under the “downloads” tab will be a link for the latest firmware and PC App.
2. On the PC that will be controlling the amplifier, unzip the file, then double-click on the “PLA DL210 Mixer Windows Installer Package” icon to install the PC Mixer App.
3. Connect the Ethernet cable between the Loop Amplifier and the Computer. If on a **network, standard ethernet cables** can be used. When connecting a computer **directly** to the amplifier using the ethernet connection, a **crossover cable** is required.
4. Open the PC Mixer App.
5. On the top menu bar, click on the wrench/screwdriver icon to open the Application Settings dialog box. See Figure J below.

Figure J: Application Settings Window

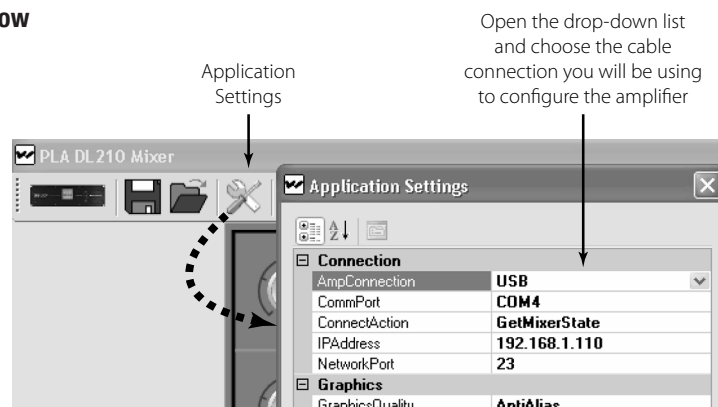

5. On the first line, choose the “AmpConnection” (Serial, Network or USB) (Figure J).
6. Set the appropriate entries for ConnectAction, ConnectOnLoad, IPAddress and NetworkPort. Note that CommPort is fixed to COM 4 and cannot be changed.
7. Turn on the Loop Amplifier and wait for it to show the Loop Status screen (the two Loop VU Meters).
8. Single-click on the “Amplifier Connect” symbol (shown in top left of Figure K). This attempts to connect the PC to the Amplifier. If the connection is successful, the color around the amplifier symbol will turn Green.
9. Begin using the PC Mixer App.

Using the PC Mixer Application and iPad App

TOOLBAR

Connect to Amplifier - This symbol establishes connection between the amplifier and the PC (or disconnects).

Save Config - Stores all of the system settings in a file.

We recommend saving the settings in a file in case of power outage or other catastrophic failure. Settings should be saved immediately after the system is calibrated.

Load Config - Loads all saved system settings from a file.

Application Settings - This is where communication between the amplifier and the PC is set up. You can also change the quality of the graphics or run a demo of the application - with simulated VU meter activity.

Reset Levels - This will reset all of the slider and rotary dial levels to -INF.

Calibration - This opens the calibration window, which provides a convenient way to calibrate the loop by generating a test tone (using the amplifier's internal tone generator), adjusting the frequency and output level, and measuring the signal level of the loop with a field-strength meter. Note: The field strength meter can be purchased through Williams Sound, model PLM FSMP. Please see our website for more information.

Loop Test - Performs a test on the loop(s) looking for an open or faulty loop.

Full-Screen View - This returns to a full-screen view if the window has been re-sized.

Saved Views 1-4 - Allows the user to save and recall custom views. This can be useful when one part of the application is used often and the user doesn't want to zoom every time. Zoom to the desired view and hold Ctrl + Left + Click to name and save the view.

Network Info - This shows the Ethernet Network Address settings and Dante Network Address settings.

System Info - This shows the currently loaded versions of: PC Application, Main CPU Firmware, DSP Chipset Firmware, and Bootloader.

Get All - This sends a request to get current information from the amplifier such as input and output levels, etc.

Figure K: PC App Toolbar

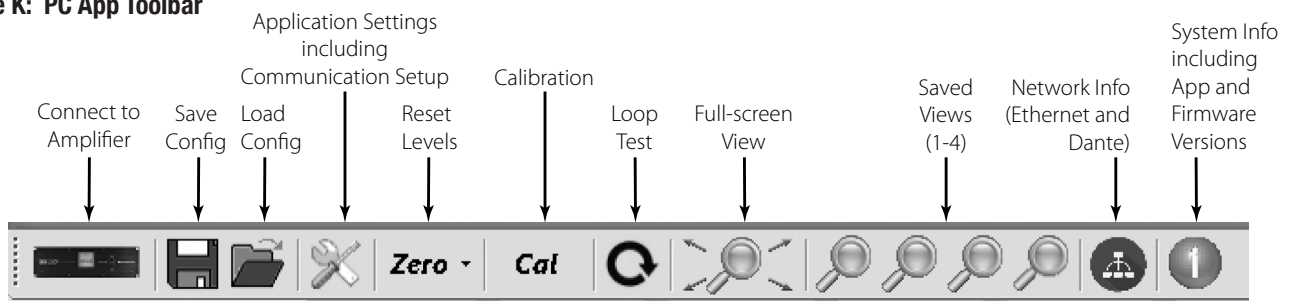
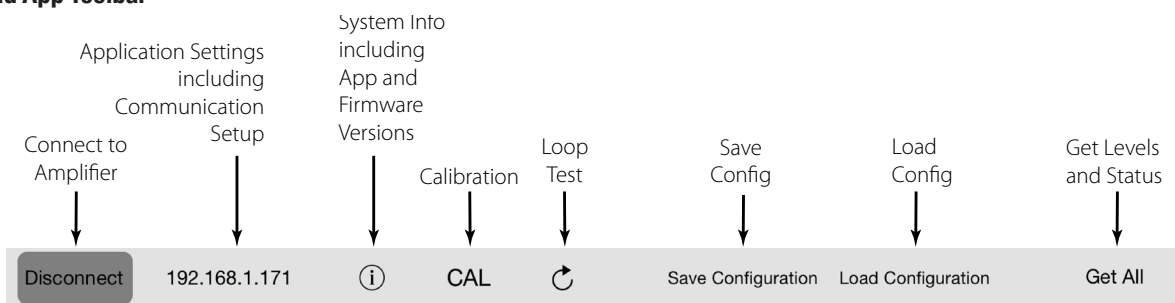

Figure L: iPad App Toolbar



PC MIXER APP MAIN SCREEN

Mix Gain - Allows an additional point of control to mix individual inputs as required for each output. (Click on the dial, then slide up/down to adjust)

Line/Mic/Phantom Mic Select - Switches between a Line-level signal, dynamic microphone or 48v condenser microphone.*

Input Trim - Provides fine trim of the input gain.

Digital In Switch - Switches “Digital In L” and “Digital In R” (inputs follow each other) to either Dante or AES/EBU.

Input Effects/Output Effects - Opens the Input or Output Effects adjustment window (see Figures M,N).

Input/Output Mute - Mutes the Input or Output without the need to use the slider control. Unmute returns to slider gain level.

Input VU Meter/Output VU Meter/Loop Output VU Meters - Shows the active level of the audio post-adjustment.

Input/Output Gain - Gain adjustment slider control.

Custom Input/Output Name - Provides the ability for a custom name. The jack label is preserved above the custom name.

Loop Modes - Changes the internal configuration of the amplifier to drive the load(s) chosen. Use “Dual Loop” mode for a single loop.

Input/Output Overload Indicators - This light will turn red once an overload condition is reached. It remains red until cleared. Clear the overload indicator by clicking on it.

Status Message Area - If the amplifier encounters error conditions, a specific message will be displayed in this area, i.e. if a loop is open.

Figure M: PC App Main Screen

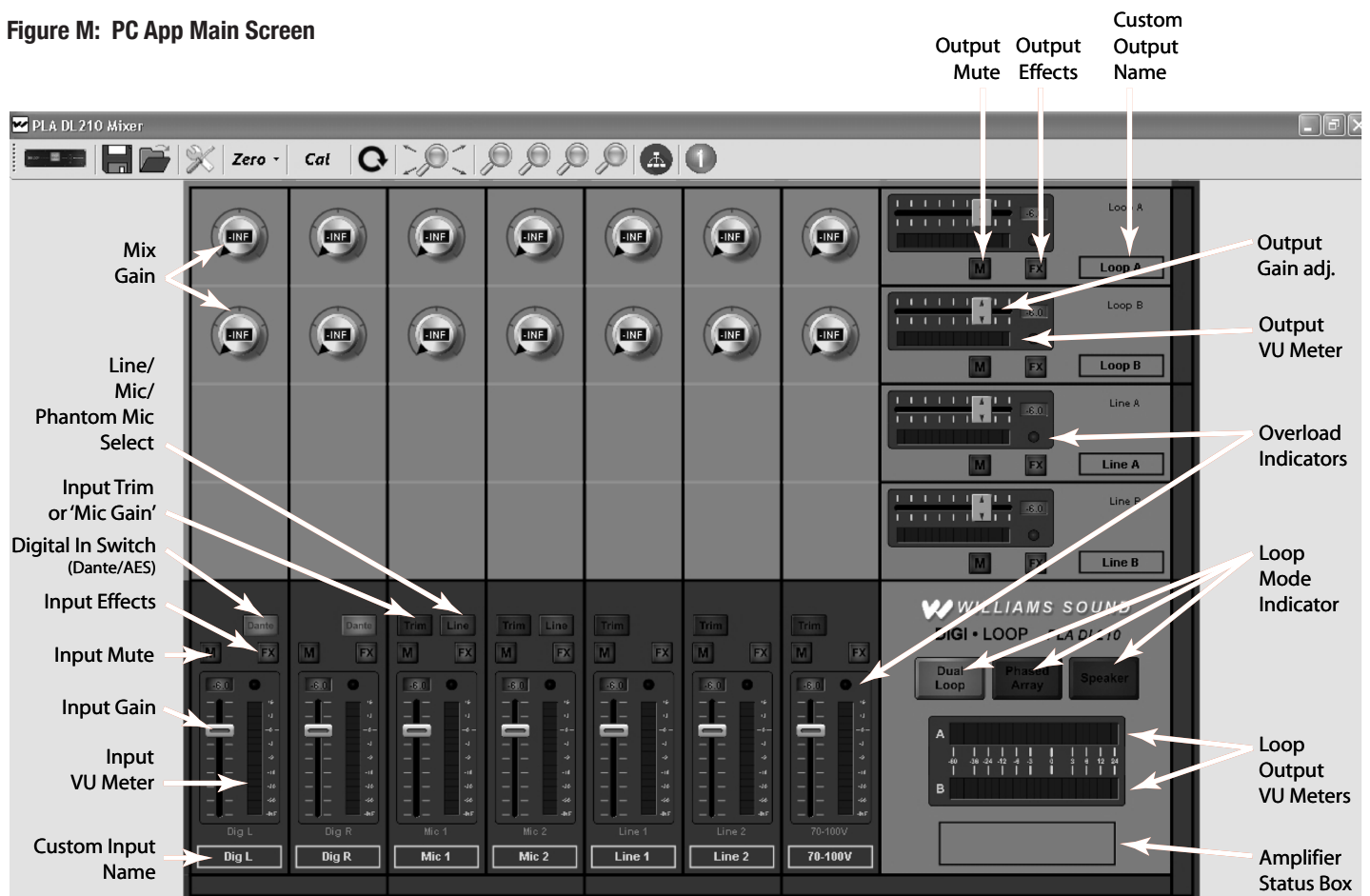

*Caution! It is very important to make sure the appropriate input configuration is set BEFORE plugging the source into the Input 1 or Input 2 jacks.

INPUT EFFECTS

Equalizer

Hz (Bass/Mid/Treble Pole Freq) - Sets the center frequency for the gain adjustment of each band. (Click then slide up/down to adjust)

dB (Bass/Mid/Treble Pole Freq Gain Adjust)- Adjusts the amount of gain at the pole frequency. This is adjustable from -96.0dB to 0.0dB in 0.5dB steps.

High Pass Filter

Each push of the button toggles between “OFF”, 31Hz, 62Hz, 125 Hz, 500Hz, and back to OFF.

Compressor

Threshold is the level of incoming signal at which compression takes effect. The Threshold is adjustable from -96.0dB to 0.0dB in 0.5dB steps.

Ratio determines how much compression is applied when it takes effect. The Ratio is adjustable from 1.0:1 (no compression) to 10.0:1 in 0.1 steps.

Attack is the speed at which compression reacts to get to the target level. The Attack is adjustable from 2ms to 500ms in 2ms steps.

Release controls the time that the compressor continues to work after the input signal drops beneath the threshold. Short settings release the signal quickly, while long release times have the effect of sustaining the signal. The Release is adjustable from 10ms to 2500ms in 10ms steps.

Makeup Gain is used to bring the overall level of the sound back up, when the overall volume has been reduced by compression. This happens when the threshold is set low and/or the ratio has been set high. The Makeup Gain is adjustable from 0dB to 40dB in 0.5db steps.

Figure N: Input Effects

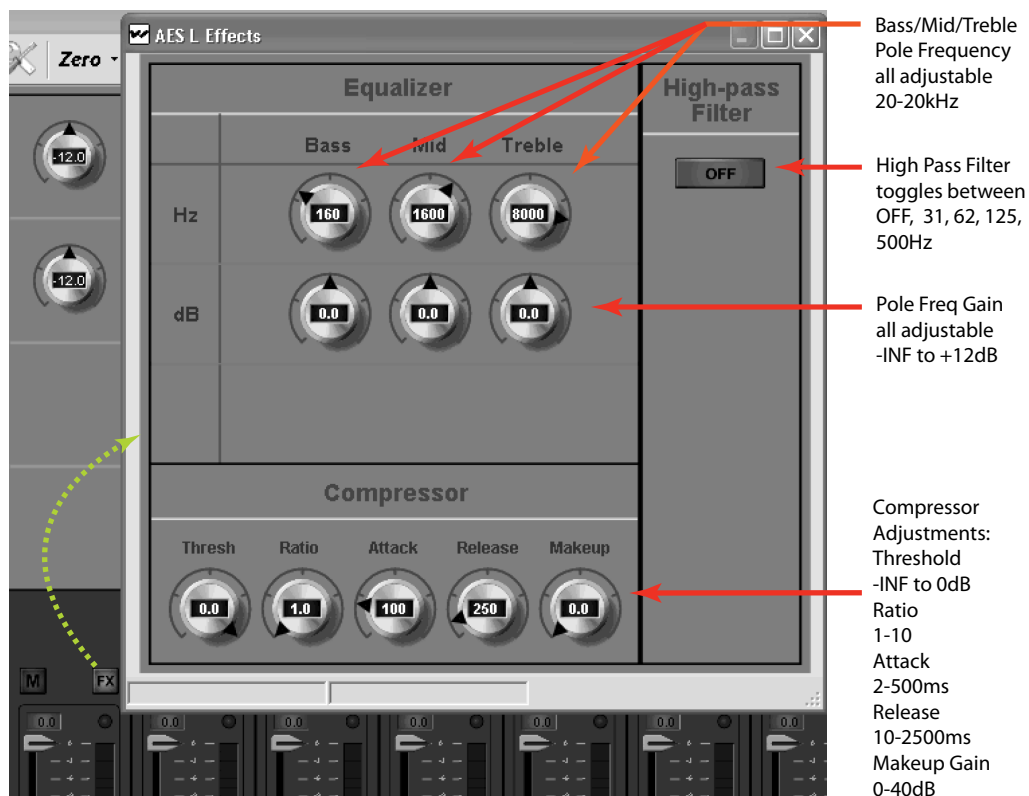

OUTPUT EFFECTS

Equalizer

Hz (Bass/Mid/Treble Pole Freq) - Sets the center frequency for the gain adjustment of each band.

dB (Pole Freq Gain Adjust)- Adjusts the amount of gain at the pole frequency.

Metal Compensation - Metal loss occurs when the environment contains metal that absorbs the energy from the loop, reducing the frequency response at high frequency. This adjustment helps overcome this loss.

AGC (Automatic Gain Control)

Once the amplifier has been calibrated for the loop(s), the AGC (when active) will try to maintain that average level of signal to the loop(s) or speaker. For people familiar with traditional AGC, this level is known as the “Target”. There is no target adjustment on the loop amplifier since *the target is internally set by calibration*.

Level This dial applies active gain correction up to ± 20 dB around the target (the Level “window”). As the dial is turned up, more correction is applied. If the audio level is *below* the target, up to +20dB (gain) is applied; *above* the target, up to -20dB (attenuation) is applied.

Hold Time is how long AGC remains at the same level when the input signal drops out of the Level Window. The Hold Time adjustable from 1 second to 60 seconds in 1 second steps. For Voice, longer hold times are often used to maintain the gain level when the speaker pauses or stops talking. For Music, shorter hold times are often used since the signal tends to be continuously present.

Attack is the speed at which the gain is boosted when the level of the input signal crosses into the “Level” window. Short settings react to the signal quickly, while long attack times have a lagging effect. When the speaker pauses, too short of an attack can result in “pumping” or “breathing” where the sound gets really loud before returning the desired level.

Release is the speed at which the gain is reduced after the input signal drops out of the “Level” window. Short settings drop the gain quickly, while long release times have the effect of sustaining the signal. Too short of a release can result in missed parts of speech due to the gain dropping off too fast. Too long of a release can result in speech getting muddled or “ringing”.

High Pass Filter

Each push of the button toggles between “OFF”, 31Hz, 62Hz, 125 Hz, 500Hz, and back to OFF. **Only use 500Hz for a speaker.**

Low Pass Filter

Each push of the button toggles between “OFF”, 16kHz, 8kHz, 6.3kHz and back to OFF.

Output Delay

The output delay can be adjusted from 0 to 165ms.

Figure 0: Output Effects

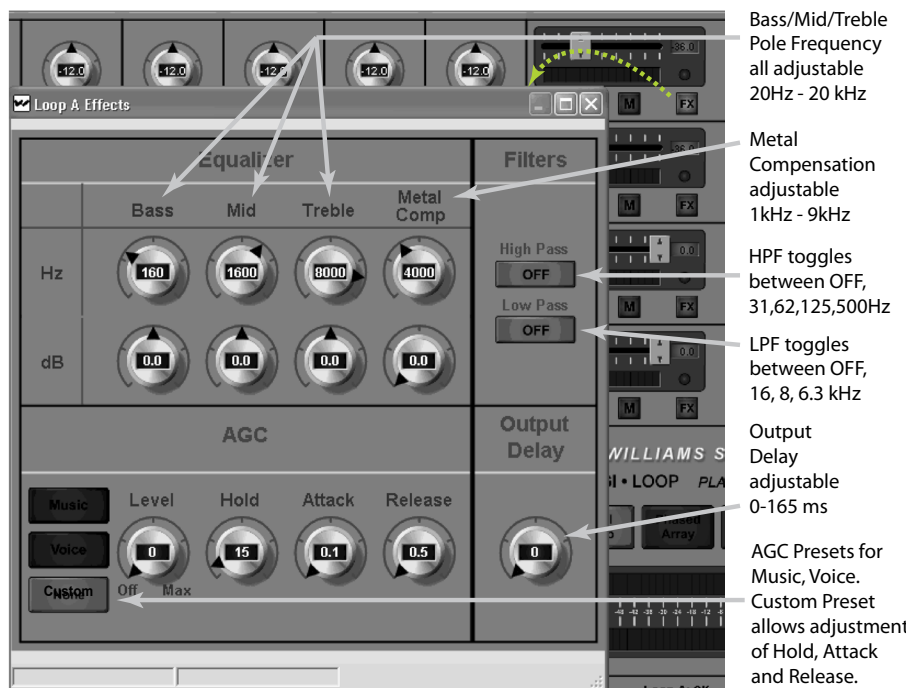

STATUS BOX AND AMPLIFIER STATUS WINDOW

The status box shows loop status at a glance. For more detail, open the Amplifier Status Window.

Figure P: Amplifier Status Window

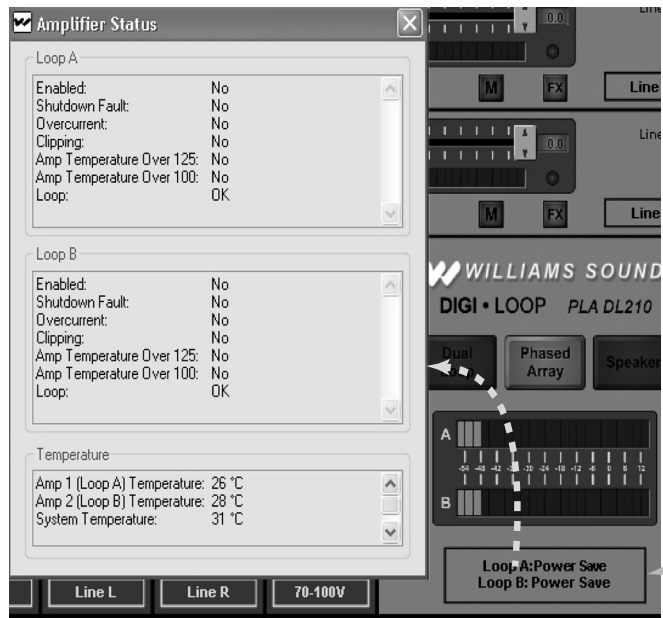

Status Box. Click inside the box to open the Amplifier Status Window.

CALIBRATION WINDOW

The amplifier must be calibrated to the loop(s) before the VU meters will be accurate. For the complete procedure on calibrating the amplifier, please refer to the section “Setup and Calibration Procedure (using a laptop or windows tablet)”. When calibrating a Phased Array, after Loop A has been calibrated with the field strength meter, switch to Loop B, and adjust the Offset for Loop B until the Average Current for Loop B matches the average current for Loop A (Figure P).

Figure Q: Calibration Window (Phased-Array Mode shown)

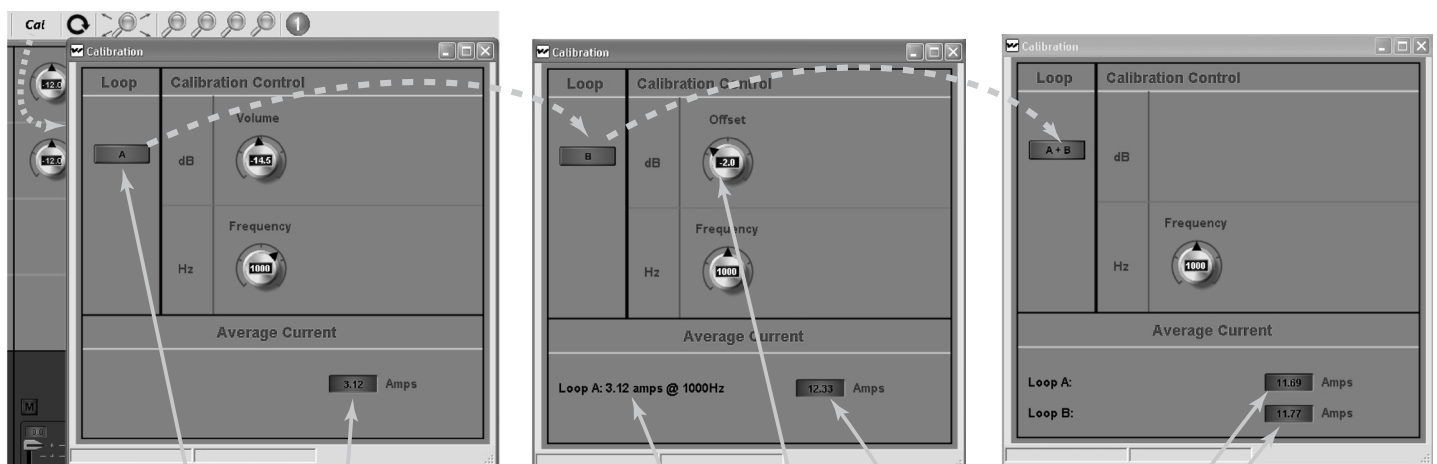

Click on this button to switch from Loop A to Loop B to Loop A+B.

Average current delivered to Loop A.

Using the current in Loop A as a reference,

adjust the offset for the current in Loop B until Loop B is close to Loop A.

When finished, the current for Loop A should be close to the current for Loop B.

Upgrading Firmware

Generally the firmware should not need to be upgraded. On those rare occasions where it has been determined the firmware needs upgrading, here is the procedure.

1. Power OFF the Loop Amplifier.
2. On the PC that will be used to upgrade the firmware, download the “PLA DL210NET PC Mixer App and Firmware Install” ZIP file.

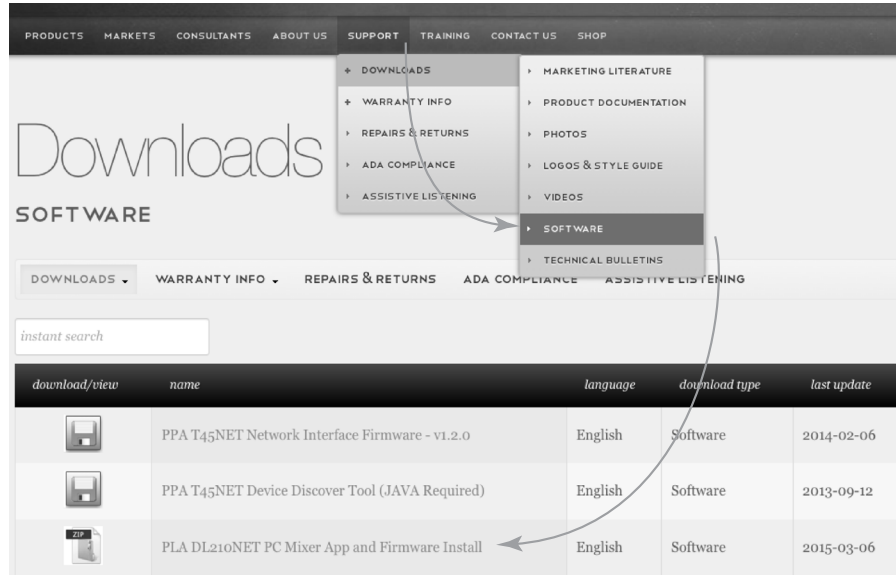

3. Unzip the ZIP file on the PC. There will be 3 files.
4. Connect a USB Device cable from the PC to the Loop Amplifier.
5. Power ON the loop amplifier.
6. Run the “DL210-update_(version number i.e.,1.144).exe” file.

⚠ Do NOT power down the amplifier or the PC or disconnect the USB cable while the firmware update is in process. ⚠

7. When the update is finished the amplifier will automatically reboot and display the new firmware version on the front screen. The firmware can also be checked by going into the menu, under “System Configuration-Tech Tools-Version”.

Note: No other devices can be connected to the loop amplifier while performing the firmware upgrade (i.e. through the ethernet connection). The PC App cannot be running on the PC that is performing the firmware upgrade. Failure to ensure that these conditions are met may result in failure of the firmware to be upgraded and could damage the unit.

Specifications

Dimensions	2U Rackmount, 19" W x 3.5" H x 12" D. Chassis is 17" W.
Weight	14.3 lbs (6.5 kg)
Color	Case: Black, white and blue legends on front, white legends on back. LCD: Backlit Blue.
Fan Cooling	Variable Speed, Temperature Controlled
Power	100-240 VAC, 50/60 Hz, 500 Watt
Heat Output	Sleep state: 83 BTU Idle State: 112 BTU Driving two loops @9A each: 286 BTU
Digital Input	(1x XLR); AES or EBU; 44.1kHz/48kHz (1x RJ-45); Dante (Model PLA DL210NET-D only)
Analog Line Inputs	(1x RCA, L+R); -10dBV, 10kΩ input impedance
Mic/Line Inputs	(2x Phoenix Terminal Block); balanced or unbalanced. Input impedance: 1.5kΩ Mic, 10kΩ Line. Configurable/accepts Mic, Line +4dBu, Line +8dBu, or Line -10dBV.
70-100v Input	(1x Phoenix Terminal Block); speaker-level input, for distributed audio systems.
Line Outputs	(2x Phoenix Terminal Block); loop-through of Mic/Line inputs 1 & 2. +4dBu. Balanced or Unbalanced.
Loop Outputs	(2x Phoenix Terminal Block). One Loop, Output A or B: 12A rms. Two Loops, Outputs A and B: 10A RMS each. 24V BTL (equiv to 48V single-ended). Measured at 1.3Ω, 1kHz standard continuous output for 8 hours.
Headphone Output	1/4" Headphone Jack, on front panel.
Required Loop Resistance	0.5Ω to 1.5Ω (DC) (stable). Amp will drive 5Ω but output current is reduced.
AGC	Gain Range: +/- 25 dB. This is effectively 50 dB of dynamic at the highest setting. The Level setting allows the dynamic range to be variable. Minimum threshold: 40 dB lower than calibration level, capped at -80 dBFS (below this level, AGC is suspended) Target level: -9 dBFS RMS (-6 dBFS peak)
Metal Loss Compensation	Parametric EQ, Tilt Correction. Center frequency: adjustable 1 KHz - 9 KHz; Level: adjustable 0 dB to +12 dB. Maximum effective tilt correction applied = +3 dB at 1 kHz to 12 dB at 9 KHz.
Output Power (Speaker)	50 Watts X 1 Channel @ 4 Ω (35 Watts @ 8 Ω). Class D.
Loop Frequency Response	100Hz to 10kHz @400mA (Output A or B). Note this may be affected by several factors.
Speaker Frequency Response	20Hz - 20kHz (Output A)
Speaker Dynamic Range	>90 dB; A-weighted, typical
Speaker THD+N	0.07%; 50 watts into 4Ω @ 20-20kHz
Loop THD	<1% at nominal power output, 1kHz sine wave
Front Controls	Front LCD display menu access/adjustment via control dial.
Remote Control/Configuration	Ethernet, USB, RS-232. Application "PC Mixer App" supports all 3 protocols.
Ethernet, Dante	Standard RJ-45 jack.
RS-232	Standard DB-9 COM port connector.
USB	Standard-B jack. USB 1.1, 2.0 or 3.0 supported.
Warranty	2 year limited
Approvals	CE, IC, UL, ULC, FCC, Industry Canada, RoHS, WEEE, CE, UL, CB scheme, cū

PLA DL107NET-D Dante Specifications:

Channels	2 (either channel can be off, mixed, or summed to the loop output)
Minimum Latency	2 ms (set in Dante Controller, stored in Dante card)
Network Speed	100 Mbps
Audio Sample Rates	44.1 KHz, 48 KHz
Resolution	24 bits

Troubleshooting

Problem	Solution
No Sound	<ul style="list-style-type: none"> - Check to see that the loop amplifier is on. - Make sure the input source is on/playing. - On the “Loop Status” screen, the horizontal bar graph should be pulsing with the audio from the input source. - Plug in headphones and make sure the input source is producing audio. - Check loop connections - are both loop ends connected firmly and are the cable ends properly terminated with exposed wire in the contacts (insulation stripped off)?
Interference / Hum / Background Noise	<ul style="list-style-type: none"> - Are hearing aids/receivers on/set correctly? - Turn the loop system off and check to see if background noise remains. If it does, the noise may be created by other electrical systems and picked up by the loop. Turn off nearby appliances to find the source of the interference. - If a microphone is connected to the microphone input, try shutting off the microphone or unplugging it. If the noise goes away, turn it back on and try reducing the microphone input gain.
Announcements Not Heard	<ul style="list-style-type: none"> - Is the announcement source on and working? Can announcements be heard on the 70-100v speakers? - Check connections to the amplifier. Is the announcement source connected to the 70-100v input? - If the announcement source is properly connected, try increasing the input gain on the loop amplifier, or the output gain of the 70-100v source.

2-year Warranty

Williams Sound products are engineered, designed, and manufactured under carefully controlled conditions to provide you with many years of reliable service.

Williams Sound warrants the *PLA DL210 Digi-Loop™ DSP Induction Loop Amplifier* against defects in materials and workmanship under normal use and conditions for 2 years from date of purchase.

This warranty is available to the original end purchaser of the product and CAN BE transferred to subsequent purchasers of the product.

Microphones, earphones, headphones, batteries, chargers, cables, carry cases, and most other accessory products carry a 90-day warranty.

Williams Sound has no control over the conditions under which this product is used. Williams Sound, therefore, disclaims all warranties not set forth above, both express and implied, with respect to the *PLA DL210 Digi-Loop™ DSP Induction Loop Amplifier*, including but not limited to, any implied warranty of merchantability or fitness of use of such equipment including, without limitation, any warranty that the use of such equipment for any purpose will comply with applicable laws and regulations. Williams Sound shall not be liable to any person or entity for any medical expenses or any direct, incidental or consequential damages caused by any use, defect, failure or malfunctioning of the product, whether a claim for such damages is based upon warranty, contract, tort or otherwise, the sole remedy for any defect, failure or malfunction of the products is replacement of the product. No person has any authority to bind Williams Sound to any representation or warranty with respect to the *PLA DL210 Digi-Loop™ DSP Induction Loop Amplifier*. Unauthorized repairs or modifications will void the warranty. This warranty is void if damage occurred because of misuse, or if the product has been repaired or modified by anyone other than a factory authorized service technician. Warranty does not cover normal wear and tear on the product or any other physical damage unless the damage was the result of a manufacturing defect. Williams Sound is not liable for consequential damages due to any failure of equipment to perform as intended. Williams Sound shall bear no responsibility or obligation with respect to the manner of use of any equipment sold by it.

This warranty does not cover reimbursement for your costs of removing and transporting the product for warranty service evaluation or installation of any replacement product provided under this warranty.

The exclusions and limitations set out above are not intended to, and should not be construed so as to contravene mandatory provisions of applicable law. If any part or term of this Disclaimer of Warranty is held to be illegal, unenforceable, or in conflict with applicable law by a court of competent jurisdiction, the validity of the remaining portions of this Disclaimer of Warranty shall not be affected, and all rights and obligations shall be construed and enforced as if this Limited Warranty did not contain the particular part or term held to be invalid. The terms of the warranty are governed by the laws of the State of Minnesota.

Prices and the specifications of the products are subject to change without notice.

*For Complete Warranty Statement go to: www.williamssound.com/warranty-statement

NOTICE: Williams Sound products are NOT designed for use in extreme temperature, humidity or chemical environments. The introduction of chemicals such as chlorine, salt water or human sweat into the product will cause damage to the circuitry. Damage due to these causes is NOT covered under the Product Warranty.

If you experience difficulty with your system, call Toll-Free for Customer Assistance 1-800-843-3544 (U.S.A.) or +1 952 943 2252 (Outside the U.S.A.)

If it is necessary to return the system for service, your Customer Service Representative will give you a Return Authorization Number (RA) and shipping instructions.



10300 Valley View Rd · Eden Prairie, MN 55344
800-328-6190 / 952-943-2252 · FAX: 952-943-2174
www.williamssound.com